



OPERATOR'S MANUAL ***TRIMMER/ BRUSHCUTTER***



SRM-1500
SRM-1500A
SRM-2300

999222-01827

 **CAUTION**
READ RULES FOR SAFE OPERATION
AND INSTRUCTIONS CAREFULLY

INTRODUCTION

ECHO Trimmer/Brushcutter Models SRM-1500 and SRM-2300 are lightweight, high performance, gasoline powered units designed for weed control, grass trimming and light brush cutting in areas difficult to control by any other means.

This manual provides the information necessary for assembly, operation and maintenance.

The SRM-1500 is a blade convertible trimmer/brushcutter. Additional items are needed to use

blades on this unit. If you wish to convert the unit to a brushcutter, obtain the BLADE CONVERSION KIT from your authorized ECHOdealer.

The SRM-2300 is a blade capable trimmer/brushcutter. The metal shield and Tri-Cut blade are standard equipment with this unit.

Refer to the appropriate section of this manual for the correct use of either unit as a trimmer or brushcutter.

CONTENTS

Safety	2
Description	6
Operation	7
Troubleshooting	17
Service	18
• Replacing Line	21
• Installing Head	22
• Installing Blades	23
Assembly	26
SRM-1500A Supplement	27
Storage	29
Specifications	30

SAFETY

UNDERSTAND SAFETY WARNINGS

 **DANGER:** This symbol is used to call attention to procedures that must be followed to avoid the risk of serious immediate and irreversible human injury or death.

 **CAUTION:** This symbol is used to call attention to procedures that must be followed to avoid serious, although not necessarily always immediate, risk of human injury or death.

FOLLOW SAFETY INSTRUCTIONS

Follow all danger and caution warnings in this manual and on safety decals on the trimmer.

FOLLOW SAFETY DECALS

Safety decals are placed on your trimmer for your protection. Make sure decals are legible and that you understand and follow the instructions on them.

SAFETY

USE TRIMMER/BRUSHCUTTER AS INTENDED

▲ DANGER: Serious injury may result from improper use of metal blades. Comply with all Safety Instructions in the Operator's Manual and supplied with the blades.

1. The Echo 8-tooth blade is designed to cut brush and small trees.

▲ DANGER: To avoid injury due to kickout or blade fracture, do not use the 8-tooth and Tri-Cut blades to cut brush or trees.

2. The Echo 8-tooth blade and Tri-Cut blade are designed to cut heavy weeds and grass.
3. ECHO INC. will not be responsible for the failure of cutting devices which have not been tested and approved by ECHO for use on this unit.

SAFETY

HANDLE FUEL SAFELY

ALWAYS store gasoline in an approved container.
DO NOT smoke while handling gasoline.
ALWAYS stop the engine before refueling.
DO NOT refuel a hot engine. Wait until engine cools.
ALWAYS remove the fuel cap slowly in order to relieve any pressure built up in tank.
DO NOT overfill the tank and always wipe up spilled fuel.
ALWAYS restart the engine at least 10 feet away from refueling point.



AVOID CARBON MONOXIDE

DO NOT operate in a confined area.

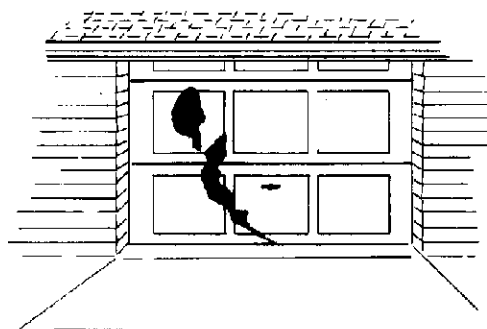

KEEP PEOPLE AND ANIMALS AWAY

DO NOT operate if people or animals are in work area.

CLEAR WORK AREA

Before starting, inspect work area and remove stones or any other foreign objects such as cans, bottles and wire.



SAFETY

WEAR PROTECTIVE CLOTHING AND EQUIPMENT

ALWAYS wear safety protection that meets ANSI Z87.1 standards, while operating the unit.

- Always wear gloves and non-skid footwear.
- Dress properly with snug fitting, durable clothing and avoid loose clothing.
- Always wear eye protection such as safety goggles or glasses when operating the unit.

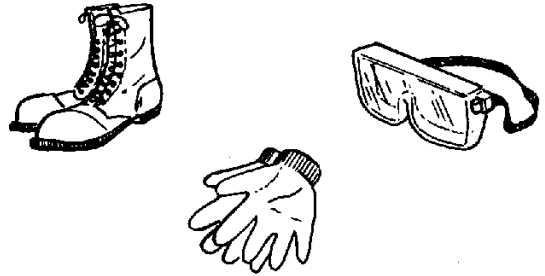

OPERATE SAFELY

DO NOT operate the unit when you are fatigued.

ALWAYS remain alert when operating the unit to avoid possible injury to yourself and other people.

DO NOT operate the unit while under the influence of drugs or alcohol.



USE CORRECT TECHNIQUE

ALWAYS hold the unit firmly with both hands and with fingers and thumbs encircling the handles.

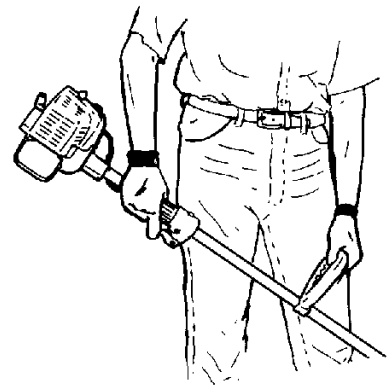

DESCRIPTION

CONTROLS

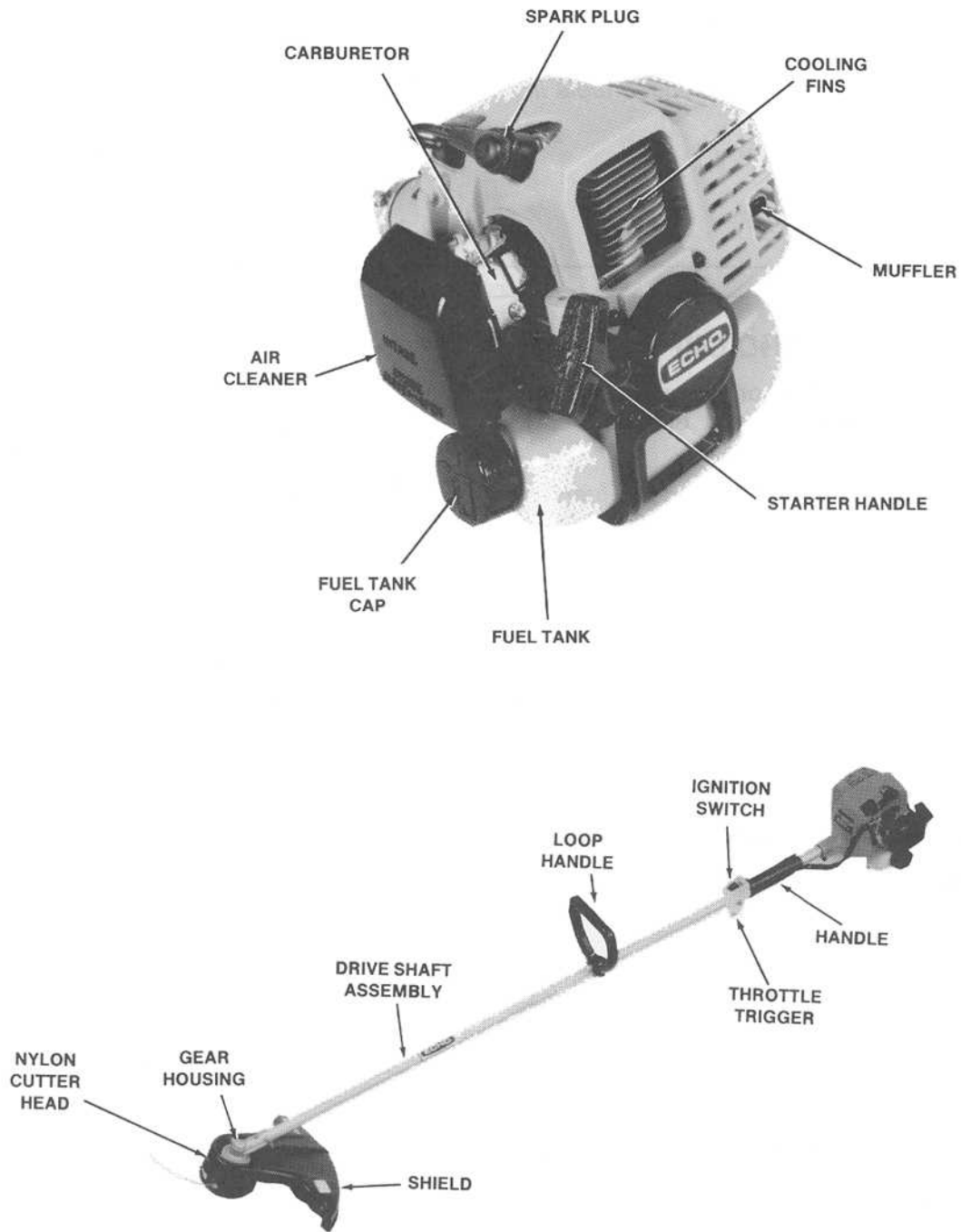

OPERATION (GENERAL)

2-STROKE FUEL (32:1, ECHO OIL)

Use a mixture of 32 parts leaded or unleaded regular grade gasoline (min. Octane 87) and one part 32:1 ECHO 2-stroke oil.

NOTE: Do not use gasohol or alcohol blended fuels in this engine.

2-STROKE FUEL (50:1, ECHO OIL)

Use a mixture of 50 parts leaded or unleaded regular grade gasoline (min. Octane 87) and one part 50:1 ECHO 2-stroke oil.

NOTE: Do not use gasohol or alcohol blended fuels in this engine.

MIX FUEL

NOTE: Use only oils recommended above.

NOTE: Do not mix fuel in engine fuel tank.

- Pour 1/2 of the gasoline into a safe container.
- Add oil to gas and mix.
- Add remaining gasoline and remix.
- Install fuel tank cap and wipe spilled fuel from container and area.

CHECK TRIMMER CONDITION

1. Check for loose nuts, bolts and screws before using unit.

OPERATION (GENERAL)

SAFE STARTING TECHNIQUES

NOTE: Use short pulls, 1/2 to 2/3 rope length, when pulling starting rope.

NOTE: Do not allow the starter handle to snap back against the housing.

NOTE: Always hold the unit firmly.

COLD ENGINE STARTING

⚠ CAUTION: When engine starts, the head may rotate even with trigger in low speed position.

1. Slide ignition switch to START/RUN position.

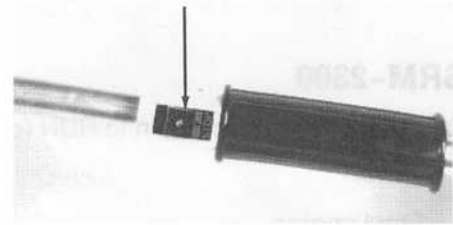

SRM-1500

2. Turn choke lever to COLD START (closed) position.

SRM-2300

2. Pull choke knob up to COLD START (closed) position.



SRM-1500

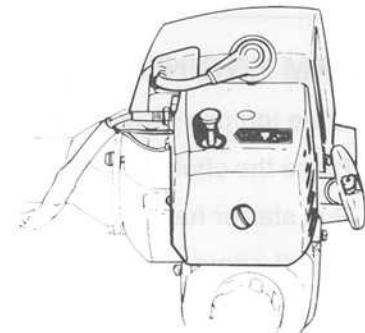

SRM-2300

OPERATION (GENERAL)

3. Depress throttle trigger lightly.
4. Pull starter handle several times until engine fires once.

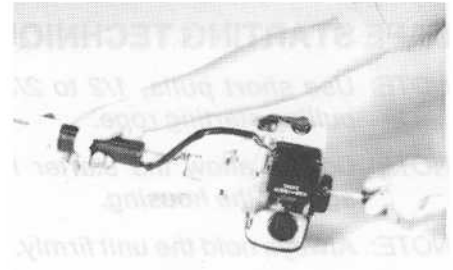

SRM-1500

5. Turn choke lever to RUN (open) position.

SRM-2300

5. Push choke knob down to RUN (open) position.
6. Start engine.
7. Release throttle trigger and allow engine to warm up.
8. Squeeze throttle trigger gradually.



SRM-1500

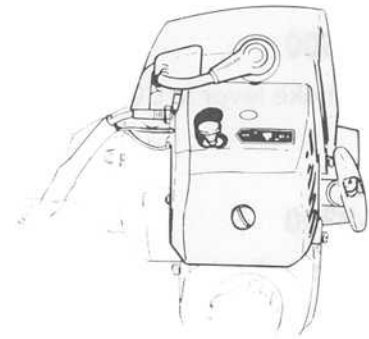

SRM-2300

WARM ENGINE STARTING

1. Slide ignition switch to START/RUN position.
2. Place the choke lever in the RUN (open) position.
3. Pull starter handle.

NOTE: If engine does not start after 4 pulls, use cold start procedure.

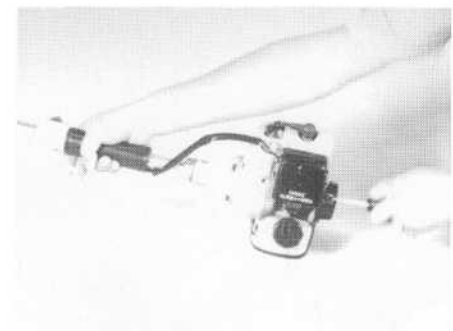

STOPPING ENGINE

1. Release throttle trigger and allow engine to idle.
2. Slide ignition switch to "STOP" position.

 **CAUTION:** If engine does not stop, close choke lever to stop engine. Check and repair stop switch before starting engine again.



OPERATION (NYLON LINE)

OPERATE SAFELY AND AVOID DAMAGE TO TRIMMER

- Keep both hands on handles when engine is running.
- If cutter becomes clogged, stop engine and clean cutter.
- Do not overreach or stand on unstable surfaces.
- If the cutter head strikes an obstruction or is prevented from turning freely, stop engine and inspect cutter head for damage.
- If the trimmer is operated for extended periods in high temperatures, the drive shaft housing may become very hot (too hot to touch). Allow unit to cool and check lubrication as outlined in service section before continuing.
- To avoid engine damage, do not run at full throttle without load.

ADJUSTING LINE LENGTH

RECOMMENDED LINE LENGTH: 13 cm (5 in.) Measure from cut-off knife to edge of cutting head.

NOTE: Grass cutting is done with the tip of the line. Cutting with entire length of the line will result in the line snapping or fraying.

1. With engine running at normal operating speed, tap head firmly on the ground.

NOTE: One inch of line will be released each time head is tapped. Cut-off knife will keep line at proper length.

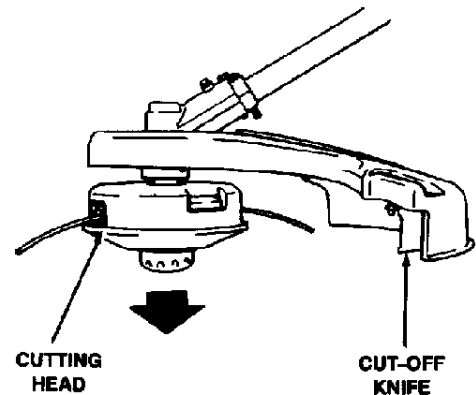

OPERATION (NYLON LINE)

TRIMMING

1. Place trimmer so cutter is facing straight ahead.

⚠ CAUTION: Cutting with the head tilted to the right will result in debris being thrown towards operator.

2. Trim from right to left, tilting the unit slightly to the left, allowing the debris to be thrown away from the operator.

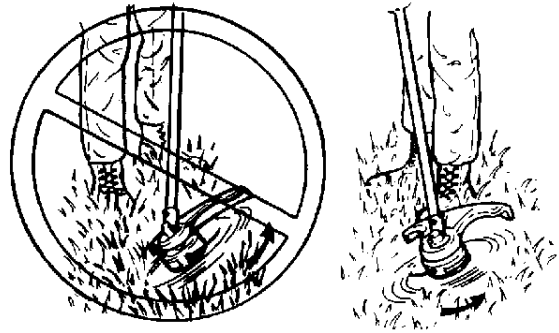

SCALPING

NOTE: Scalping is the removal of all vegetation down to the ground.

1. Tilt the cutter head about 30 degrees to the right.

NOTE: Scalping is very effective around trees and shrubs, but care should be taken not to bruise bark and young sensitive growth.

NOTE: When trimming around flowers, keep in mind that line cuts in a full circle around the head.



EDGING

1. Tilt cutter head at right angles to the ground.
2. Adjust handle bracket to fit edging position.
3. Allow line to skim along edge of the concrete or other hard surface when edging.

⚠ DANGER: Do not edge with metal blades. Edging must be done only with nylon line trimmer head.

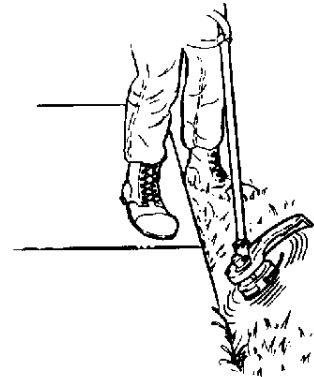

SWEEPING

1. Tilt cutter head slightly to the right.
2. Swing cutter head side to side.



OPERATION (NYLON LINE)

MOWING

⚠ DANGER: During this operation, debris may be thrown in any direction. Always wear safety glasses or goggles when using trimmer.

1. Hold cutter head parallel to the ground and operate at full throttle.

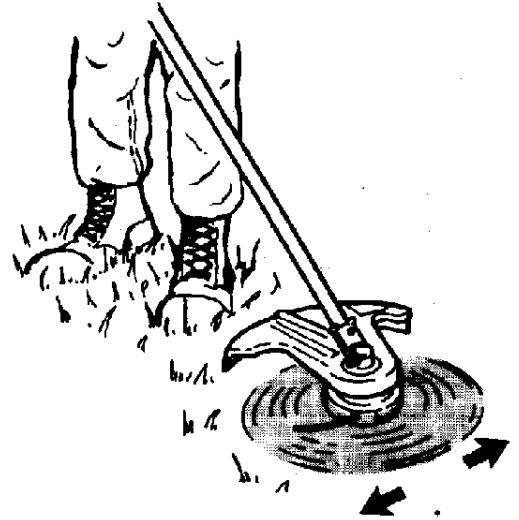

OPERATION (BLADE)

BLADE TYPES

			SRM-1500	SRM-2300
Steel 8-inch blade (8 tooth)	Weed and Grass	696 001-2033 0	Optional	Optional
Steel 8-inch blade (80 tooth)	Brush and Small Trees	695 001-0833 0	Optional	Optional
Nylon Tri-Cut blade	Weed and Grass	999 442-0003 0	Optional	Standard

USE CORRECT BLADE

DANGER

1. Serious injury may result from the improper use of steel blades. Read and comply with all safety instructions listed in this manual.
2. The eight-tooth blade and Tri-Cut blade are designed specially to cut weed and grass. To avoid injury due to kickout or blade fracture, **DO NOT** use the Tri-Cut blade or eight-tooth blade to cut brush or trees.
3. ECHO INC. will not be responsible for the failure of cutting devices which have not been tested and approved by ECHO for use with this unit.

OPERATE BRUSHCUTTER SAFELY

- Always use the blade suited for the job.
- Do not hit rocks, stones, tree stumps and other foreign objects with blade.
- Do not cut into the ground with the blade.
- If blade strikes an obstruction, stop engine immediately and inspect blade for damage.
- Do not operate with a dull, bent, fractured or discolored blade.
- Do not run engine at full throttle without a load.
- Remove all foreign objects from work area.
- Do not operate brushcutter without harness and shield correctly fitted.
- In case of an emergency, use quick release latch on harness to free yourself from trimmer.
- ECHO strongly recommends the use of a U-Handle Kit for use with blades.
- Always use metal shield with metal blades.

OPERATION (BLADE)

USING SHOULDER HARNESS

⚠ CAUTION: Shoulder harness must be worn when using blades.

1. Place shoulder harness over left shoulder and adjust straps so the quick release latch rests just below the waist.
2. Attach Trimmer/Brushcutter to harness.
3. Check for correct adjustment by moving cutter along ground.
4. Readjust bracket (if necessary).

⚠ CAUTION: In case of emergency, pull the quick release pin to disconnect the trimmer from the harness.

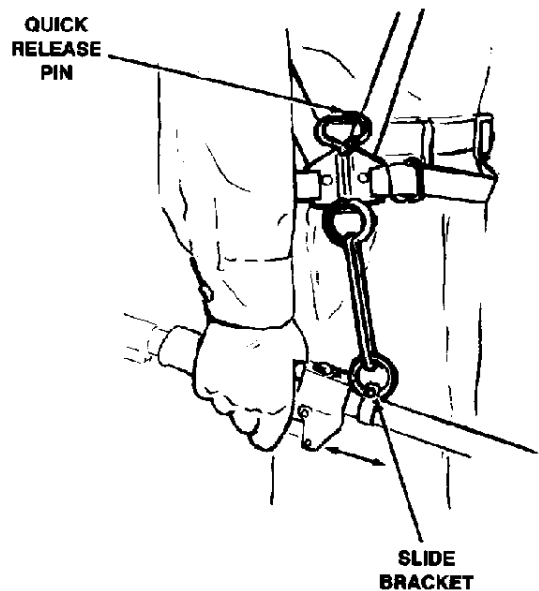

HEAVY WEED CUTTING (Eight-tooth 8-inch blade or Tri-Cut blade)

1. Install metal shield.
2. Install 8-tooth blade or Tri-Cut blade (see page 23 or 25 for installation).
3. Start the engine.
4. Allow engine to warm up.
5. Depress throttle.
6. Swing blade in an arc as you move forward.



BRUSHCUTTING (80-Tooth Blade)

1. Install metal shield.
2. Install the 80-tooth blade (see page 23 for installation).
3. Follow heavy weed cutting procedure.



OPERATION (BLADE)

CUTTING SMALL TREES

NOTE: The unit is designed to cut small trees up to 3 inches in diameter when equipped with the 80-tooth blade.

1. Make sure the tree will fall away from you before attempting to cut it.

NOTE: It may be necessary to tie a rope to the tree to guide it in a safe direction.

NOTE: Do not attempt to use the brushcutter like an axe. Doing so will result in damage to the brushcutter.

2. Brace your feet firmly on the ground and cut with the left-hand side of the blade. Feed the blade slowly into tree.

⚠ CAUTION: Always cut on full throttle. Never try cutting with a dull blade.

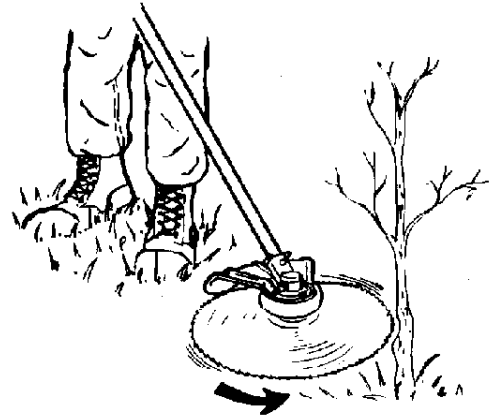

TROUBLESHOOTING

TROUBLE	CAUSE	WHAT TO DO
1. Engine fails to start.	<p>No fuel in tank. Fuel filter clogged. Fuel line clogged. Spark plug shorted or fouled. Spark plug broken (cracked porcelain or electrodes broken). Ignition lead wire shorted, broken or disconnected from spark plug. Ignition inoperative (no spark from lead wire).</p>	<p>Fill tank. Replace filter. Clean fuel line. Install new spark plug. Replace spark plug. Replace lead wire or attach to spark plug. Contact your nearest authorized dealer.</p>
2. Engine hard to start.	<p>Water in gasoline or stale fuel mixture. Too much oil in fuel mixture. Engine over or under choked. Carburetor out of adjustment. Gasket leaks (carburetor or cyl. base gasket). Weak spark at spark plug.</p>	<p>Drain entire system and refill with fresh fuel. Drain and refill with correct mixture. If flooded by over choking, proceed according to instructions in previous section. If under choked, move choke lever to closed position and crank two or three times. See "Carburetor Adjustment." Contact your nearest authorized dealer. Contact your nearest authorized dealer.</p>
3. Engine misses.	<p>Dirt in fuel line or carburetor. Carburetor improperly adjusted. Spark plug fouled, broken or incorrect gap setting. Weak or intermittent spark at spark plug.</p>	<p>Remove and clean. See "Carburetor Adjustment" in service section. Clean or replace spark plug – set gap to 0.6-0.7 mm (0.024-0.028 in.). Contact your nearest authorized dealer.</p>
4. Engine lacks power.	<p>Air cleaner clogged. Carburetor out of adjustment. Muffler clogged. Clogged exhaust ports. Poor compression.</p>	<p>Clean air cleaner. See "Carburetor Adjustment." Clean carbon from muffler. Remove muffler, rotate engine until the piston is at bottom of cylinder. With a wooden scraper or blunt tool, remove all carbon from exhaust ports. Be careful not to scratch or damage piston or cylinder walls. Blow out loose carbon with compressed air. Start engine and run briefly to remove all carbon, then install muffler and gasket. Contact your nearest authorized dealer.</p>
5. Engine overheats.	<p>Insufficient oil in fuel mixture. Air flow obstructed.</p>	<p>Mix fuel as shown in starting instructions. Clean flywheel and cylinder fins.</p>
6. Engine noisy or knocking.	<p>Spark plug incorrect heat range. Worn bearings, piston rings or cylinder walls.</p>	<p>Replace with plug specified for engine. Contact your nearest authorized dealer.</p>
7. Engine "stalls" under load.	<p>Carburetor main adjustment too "lean." Engine overheats.</p>	<p>See "Carburetor Adjustment." See "Cleaning Cylinder Fins" in service section.</p>

SERVICE

CLEANING AIR FILTER (Before Each Use)

1. Remove air filter cover.
2. Remove air filter from cover (SRM-2300 only).
3. Brush dirt from filter or wash it in suitable cleaner.

*NOTE: Insure filter is undamaged and is properly fitted.
Replace if necessary.*

NOTE: Allow all parts to air dry.

4. Reinstall filter in cover (SRM-2300 only).
5. Install air filter cover.

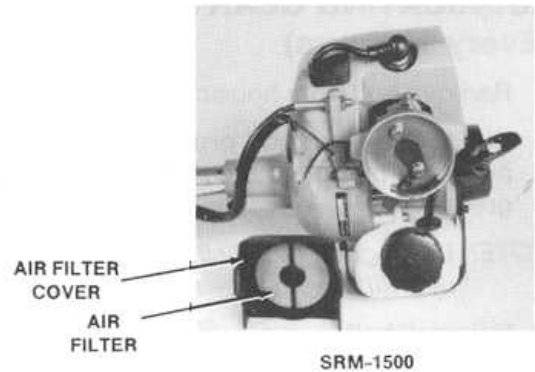

SRM-1500

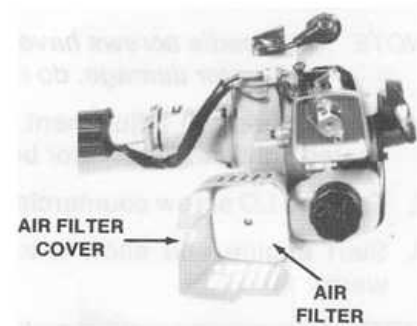

SRM-2300

REPLACING FUEL FILTER (Check Periodically)

1. Pick up fuel filter through fuel inlet port with a piece of steel wire.
2. Remove old filter.
3. Install new filter.



CHECKING SPARK PLUG (Check Periodically)

1. Check for proper gap of 0.6-0.7 mm (0.024-0.028).
2. Inspect electrode for wear.
3. Inspect insulator for oil or other deposits.
4. Replace plug, if needed, and torque to 145-155 kg-cm (125-135 in. lb).

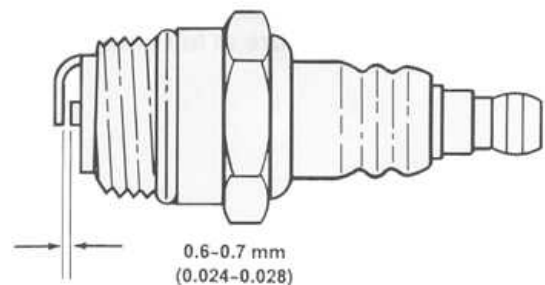

SERVICE

LUBRICATING GEAR HOUSING (Every 50 Hours)

1. Remove bolt from housing.
2. Check level and add grease if necessary using low pressure pump. Leave 1/8" space for expansion of grease.

NOTE: Use a good quality lithium multi grease. DO NOT overfill housing.

3. Reinstall bolt.

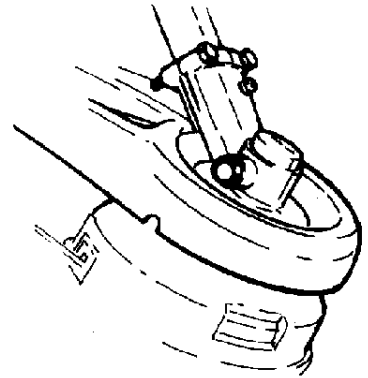

INITIAL ADJUSTMENT

NOTE: The needle screws have a sharp point. To avoid carburetor damage, do not use excessive force.

1. Turn HI and LO adjustment screws clockwise until seated lightly in carburetor body.
2. Turn the LO screw counterclockwise one turn.
3. Start engine and allow it to run at high idle until warm.

NOTE: Idle speed screw may have to be readjusted to keep engine from stalling.

CARBURETOR ADJUSTMENT (As Needed)

NOTE: The diaphragm carburetor has three external adjustments. Each adjustment affects the others.

The idle speed adjustment screw controls the throttle opening at idle position.

The low (LO) speed adjustment screw controls the volume of fuel/oil mixture at low engine speed. It also controls the supplementary fuel required to obtain smooth progression from idling to high speed.

The high (HI) speed adjustment screw controls the volume of fuel/oil mixture at full throttle.

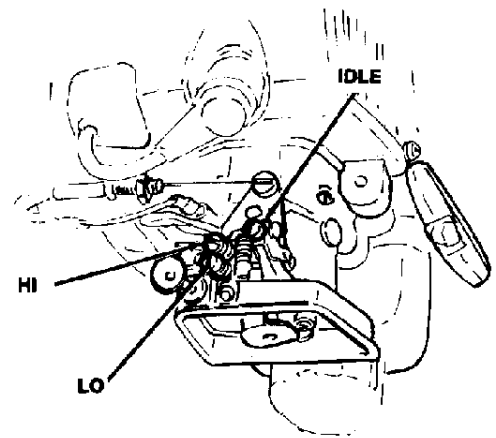

SERVICE

LOW SPEED ADJUSTMENT

1. Slowly turn the LO adjustment screw clockwise and note the position when engine speed drops.
2. Turn the LO adjustment screw counterclockwise and note position when engine speed drops.
3. Set the screw midway between these points.
4. Turn the idle speed screw clockwise until a speed of 3700 RPM is achieved (cutter head should start turning).
5. Turn idle speed screw counterclockwise one-half turn to stop cutter head from turning.



HIGH SPEED ADJUSTMENT

NOTE: Engine must be at normal operating temperature.

1. Turn the HI adjustment screw counterclockwise 1-1/4 turns.

⚠ CAUTION: Do not run the engine on full throttle longer than 5-6 seconds to avoid damage to engine.

2. While running the engine at full throttle, turn the HI adjustment screw slowly clockwise until the engine runs smoothly without four-stroking under no load.
3. Turn the screw counterclockwise 1/8 turn to obtain optimum fuel for full power under load conditions.

NOTE: It may be necessary to reset idle speed as outlined in steps 4 and 5 of "Low Speed Adjustment" section.

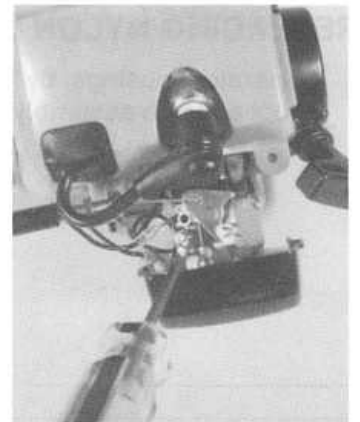

SERVICE

CLEANING MUFFLER AND EXHAUST PORT (SAM) (Clean as Necessary)

1. Remove muffler cover and muffler.

NOTE: Be careful not to scratch the cylinder or piston when cleaning the cylinder exhaust port.

2. Clean deposits from cylinder exhaust port and spark arrester screen.
3. Install muffler and muffler cover.

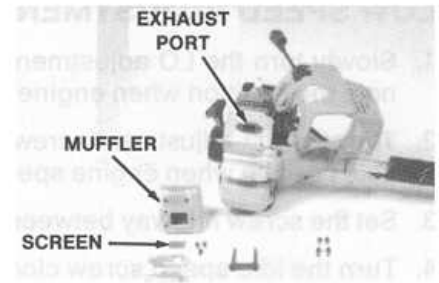

CLEANING CYLINDER FINS (Check Periodically)

1. Remove cover.
2. Remove dust and dirt from between fins.
3. Reinstall cover.



REPLACING NYLON LINE

1. Separate housings by pressing tabs and remove spool and hub assembly.

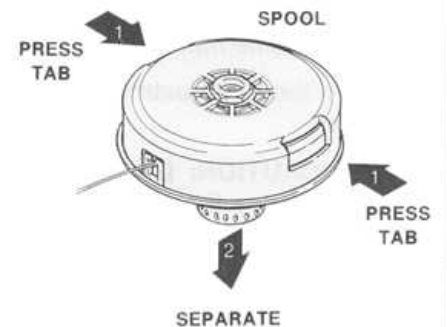

2. Thread line (15' x .095" or .105") through hole in center plate of spool and arrange line so that one end is about 5" (13 cm) longer.

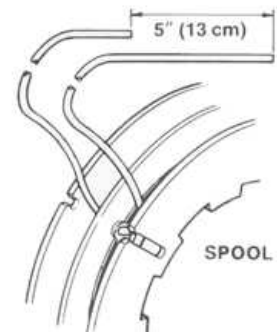

SERVICE

3. Wind both ends of line tightly in the direction of arrow marked on spool.
4. Route ends of line into notches opposite each other, marked with the diameter of the line.
5. Install hub, spool and spring in outer housing.

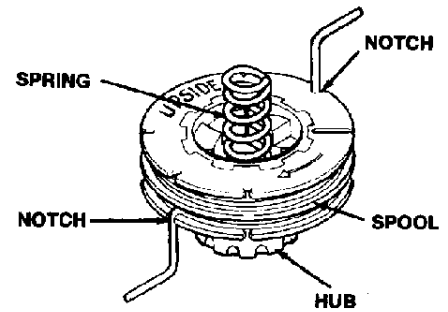

6. Remove lines from notches and route through eyelets.
7. Press two housings together until tabs snap into slots.

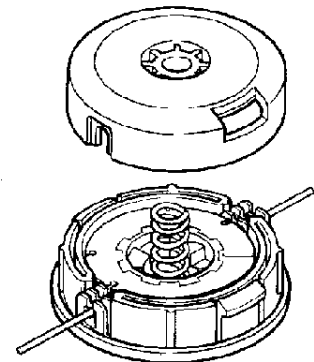

INSTALLING NYLON CUTTER HEAD

1. Rotate the drive shaft until the holes in the upper adapter plate and bearing housing are aligned.
2. Insert locking tool in holes.
3. Screw the cutter head onto the drive shaft. (Rotate the head counterclockwise to tighten.)
4. Remove locking bar.

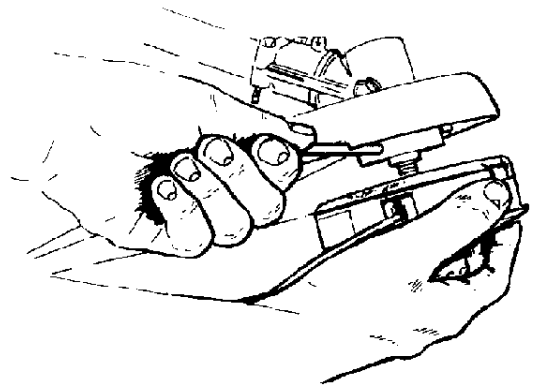

INSTALLING METAL SHIELD (For Use with Blades) (Not Standard on SRM-1500)

1. Rotate the drive shaft until the holes in the upper adapter plate and the bearing housing are aligned.
2. Insert locking tool.
3. Turn cutting head clockwise until it comes free of shaft.

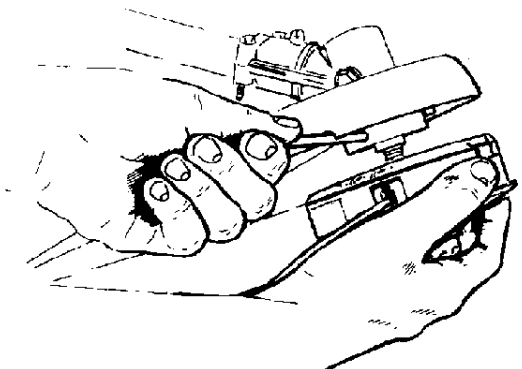

SERVICE

4. Fit shield to gear housing and secure with screws and washers.

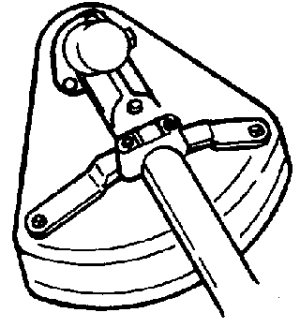

INSTALLING THE BLADE

NOTE: This procedure applies to the installation of all metal blades approved for this unit by ECHO INC.

⚠ CAUTION: Always wear proper gloves when installing blades.

1. Center blade on adapter plate.

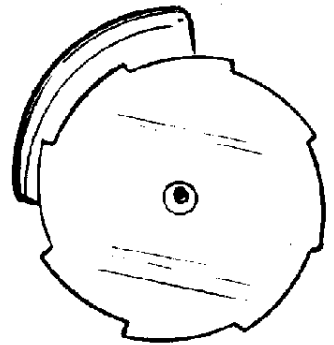

2. Fit lower adapter plate to blade and secure it with locking nut.

NOTE: The drive shaft is fitted with left-hand threads. Turn locking nut counterclockwise to tighten as viewed from bottom of unit.

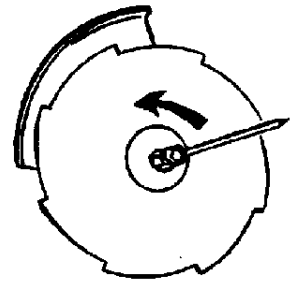

3. Secure locking nut with new split pin.

NOTE: Always use a new split pin to secure locking nut.

Split Pin
2 x 22 mm
Part No. 898 502-0113 0

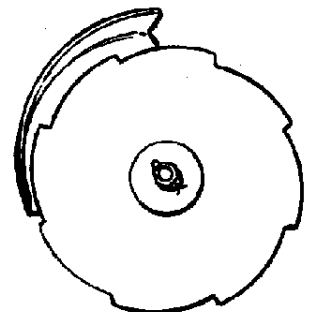

SERVICE

SHARPENING THE 8-TOOTH BLADE

1. File the bottom of the teeth to a 1-2 mm radius.

NOTE: Sharpen each cutter equally.

NOTE: If using a grinder, do not cool blade abruptly by immersing it in water.

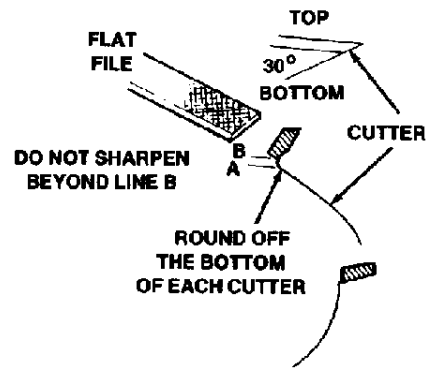

SERVICE

INSTALLING TRI-CUT BLADE

NOTE: The Tri-Cut Blade is designed for weed cutting. Do not attempt to cut heavy brush or trees with this blade.

1. Remove head.
2. Install blade (A) on shaft.
3. Install adapter (B) on shaft.
4. Align hole in adapter plate with hole in bearing housing (C) and install locking tool.
5. Install nut (D). (Rotate nut counterclockwise to tighten.)
6. Install split pin (E) in hole (F) of shaft.

NOTE: Cracked or worn Tri-Cut Blades cannot be repaired. They must be replaced.

INSTALL METAL SHIELD

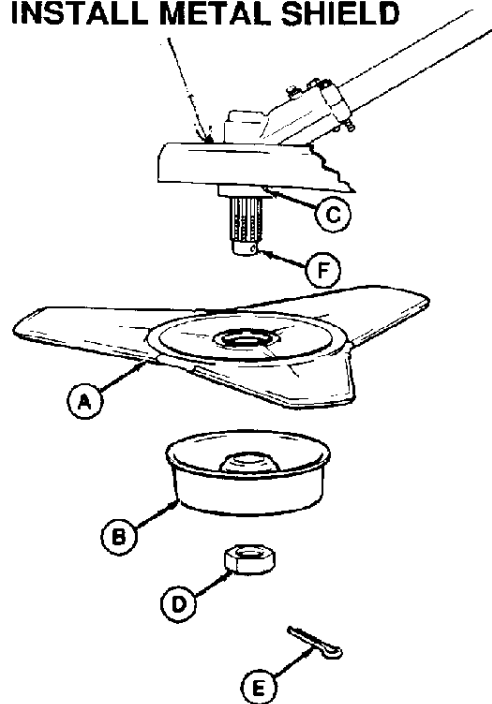

ASSEMBLY

ASSEMBLING DRIVE SHAFT (SRM-1500)

1. Stand engine upright on a level surface.
2. Loosen the bolt (A) at drive shaft end of engine.
3. Carefully fit drive shaft assembly to engine making sure the shaft is correctly engaged in clutch pilot.

NOTE: The line on the drive shaft housing must be in contact with the engine.

4. Rotate the drive shaft housing until gear housing is in line with the engine.
5. Tighten bolt.

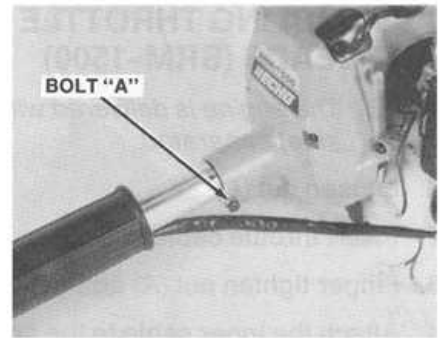

ASSEMBLING DRIVE SHAFT (SRM-2300)

1. Stand engine up on a level surface.
2. Carefully fit drive shaft assembly to engine making sure the shaft is correctly engaged in clutch pilot.
3. Secure drive shaft with four screws.

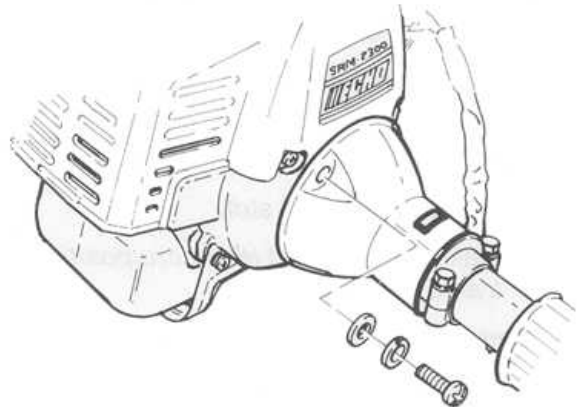

S U P P L E M E N T

For assembly instructions for the SRM-1500A:

Please refer to Page 26 of your operator manual. The SRM-1500A is equipped with an anti-vibration identical to the SRM-2300. Therefore, please use the assembly instructions for "ASSEMBLING DRIVESHAFT (SRM-2300)" to assemble your SRM-1500A driveshaft assembly.

All other assembly instructions for your model SRM-1500A are identical to the assembly instructions within the manual for the SRM-1500.



400 Oakwood Road
Lake Zurich, IL 60047

999222-01827A

12/88

ASSEMBLY

ASSEMBLING THROTTLE CABLE AND LEADS (SRM-1500)

NOTE: The engine is delivered with throttle cable (engine side) separated.

1. Loosen nut (A).
2. Insert throttle cable in slot.
3. Finger tighten nut (A) against washer and slot.
4. Attach the inner cable to the swivel (B) on the throttle lever.

NOTE: It is important that the nipple of the throttle cable fits into one side of slot of the throttle lever.

5. Tighten nut (A).
6. Check throttle for freedom of movement and make sure it returns to idle position.
7. Secure ground lead to screw (C) on housing.
8. Connect stop lead to stop lead connector (D).

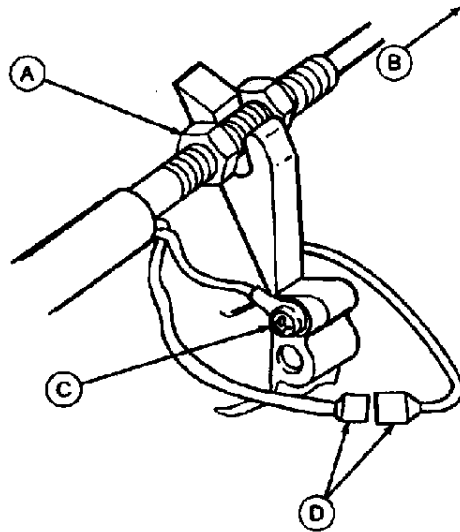

ASSEMBLING THROTTLE CABLE AND LEADS (SRM-2300)

1. Remove air filter cover.
2. Loosen nut (A) and slide ground leads (B) onto throttle cable sleeve.
3. Install throttle cable in slot.

NOTE: Make sure ground leads are positioned as illustrated.

4. Finger tighten nut (A) against leads and slot.
5. Attach inner cable to the swivel (C).

NOTE: It is important that the nipple of the throttle cable fits into one side of the throttle lever.

6. Tighten nut (A).
7. Check throttle for freedom of movement and make sure it returns to idle.
8. Connect stop lead to stop lead connector (D).

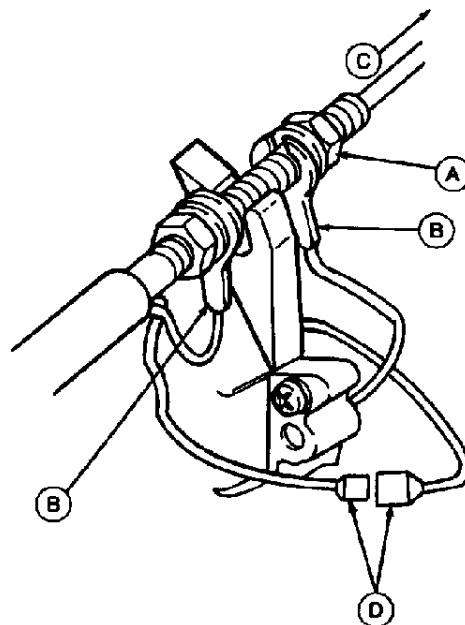

ASSEMBLY

INSTALLING LOOP HANDLE

1. Remove bolts, washers and nuts from loop handle.
2. Push the handle over the drive shaft.
3. Place handle in comfortable operating position and secure position with bolts, washers and nuts.

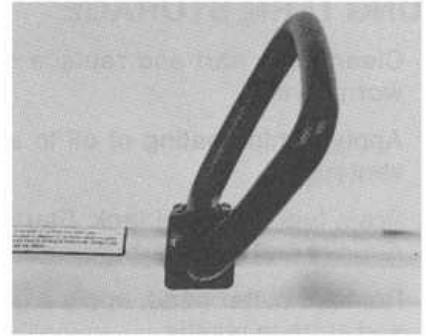

INSTALLING SHIELD (With Cut-Off Knife)

1. Install the shield on the bearing housing.
2. Secure shield to housing with screws.

NOTE: The location of the cut-off knife should be adjusted depending on the model. (Remove both nuts and cut-off knife and set as required.)

⚠ CAUTION: Do not operate trimmer without shield in correct position.

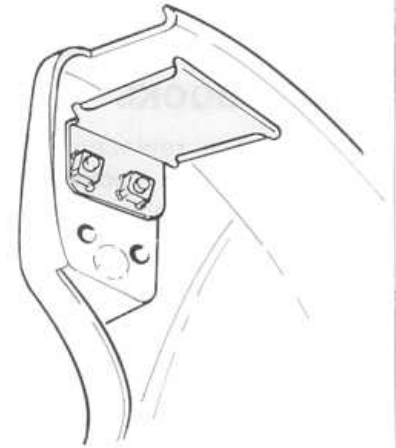

STORAGE

LONG TERM STORAGE

1. Clean each part and replace or repair damaged or worn parts.
2. Apply a thin coating of oil to all metal parts to prevent rust.
3. Drain fuel from fuel tank. Start engine and let run to remove fuel from carburetor and fuel lines.
4. Remove cutter head, apply a generous coating of oil and store in plastic.
5. Pour a small amount of clean motor oil into spark plug hole and pull starter handle until motor reaches top dead center.
6. Store in a dry area, free from dust.

PARTS BOOKS

To obtain a replacement Parts Book, complete this order form and enclose a check or money order for \$2.00. Make payable to ECHO, INCORPORATED, and mail to:

ECHO, INCORPORATED
P.O. Box 67
Lake Zurich, IL 60047

ATTN: Technical Publications

Purchaser's Name

Address (Street)

(City/State/Zip Code)

Parts Book No. 898-696-4463-0 (SRM-1500)

898-696-4473-0 (SRM-2300)

SPECIFICATIONS

Length	1770 mm (70 in.)
Width	330 mm (13 in.)
Height	300 mm (12 in.)
Weight (dry weight, without cutter and shoulder harness)	S.R.M.-1500 10.8 lbs. S.R.M.-2300 11.0 lbs.
Type of Engine	Air-cooled, two-stroke, single-cylinder, gasoline engine
Bore	32.2 mm (1.268 in.)
Stroke	26.0 mm (1.024 in.)
Displacement	21.2 cc (1.29 cu.in.)
Exhaust System	Spark arrester muffler
Carburetor	ZAMA diaphragm model C1U type
Ignition System	Flywheel magneto, capacitor discharge ignition type
Spark Plug	NGK BPM7A, CHAMPION CJ-7Y
Fuel	Mixed fuel
Fuel/Oil Ratio	32:1 ratio with ECHO two-stroke oil or 50:1 ratio with ECHO two-stroke oil
Gasoline	Alcohol free 87 Octane
Oil	ECHO two-stroke, air-cooled engine oil
Fuel Tank Capacity	0.4 lit. (13.5 oz.)
Starter System	Automatic rewind system
Clutch	Centrifugal type
Drive Shaft	1/4" flexible shaft
Rotating Direction	Counterclockwise viewed from the top
Cutter Head	Nylon line head Option: 8-tooth blade, 80-tooth blade, Tri-Cut blade
Handle	Left-D-loop, Right-grip
Gear Case	1:1.36 reduction
Anti-Vibration System	Rubber cushion (S.R.M.-2300 only)